



50-CBS Series					
		Black = inches		Red = mm	
STYLE	FIG.	A HEIGHT	B PIN SPACING	C STANDOFFS	D PIN LENGTH
50-CBS surface mount	1	.50 (12,7)	none	none	none
51-CBS	5	.50 (12,7)	1.0 (25,4)	.05 (1,27)	.12 (3,05)
52-CBS	4	.50 (12,7)	1.0 (25,4)	none	.12 (3,05)
52NN-CBS	4*	.50 (12,7)	1.0 (25,4)	none	.12 (3,05)
53-CBS	3	.50 (12,7)	.50 (12,7)	.05 (1,27)	.12 (3,05)
53A-CBS	3	.50 (12,7)	.50 (12,7)	.05 (1,27)	.06 (1,53)
54-CBS	2	.50 (12,7)	.50 (12,7)	none	.12 (3,05)
55-CBS	5	.50 (12,7)	1.0 (25,4)	.01 (.250)	.12 (3,05)
56-CBS	5	.50 (12,7)	1.0 (25,4)	.05 (1,27)	.15 (3,81)
57-CBS	5	.50 (12,7)	1.0 (25,4)	.01 (.250)	.15 (3,81)
58-CBS	2	.50 (12,7)	.50 (12,7)	none	.15 (3,81)
59-CBS	6	.50 (12,7)	.25 (6,35)	none	.12 (3,05)

- NOTES**
- Drawings in figures 1-6 are not to scale; see chart for sizing
 - Standard cover height: .280" (7,11) 50-CBS
 - Other cover heights available, consult factory
 - *52NN-CBS has no v-notches as depicted in fig. 4



FIGURE 1 Surface Mount

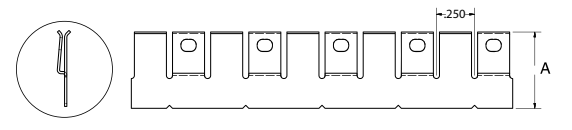

FIGURE 2 .50" Pin Spacing, No Standoff

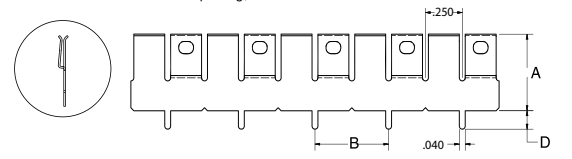

FIGURE 3 .50" Pin Spacing, With Standoff

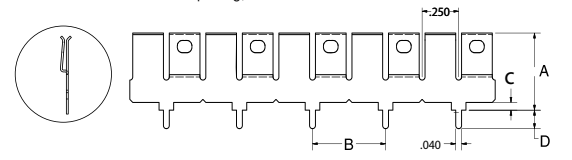

FIGURE 4 1.0" Pin Spacing, No Standoff

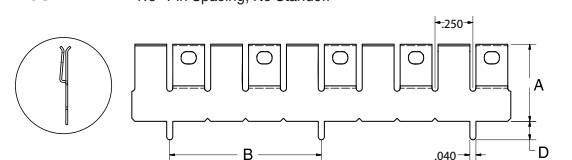

FIGURE 5 1.0" Pin Spacing, With Standoff

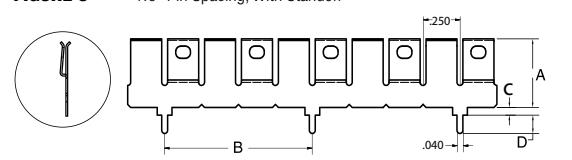
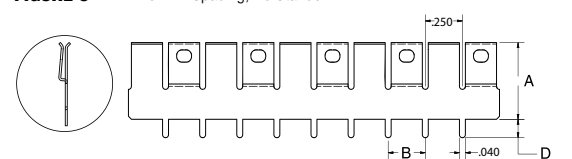
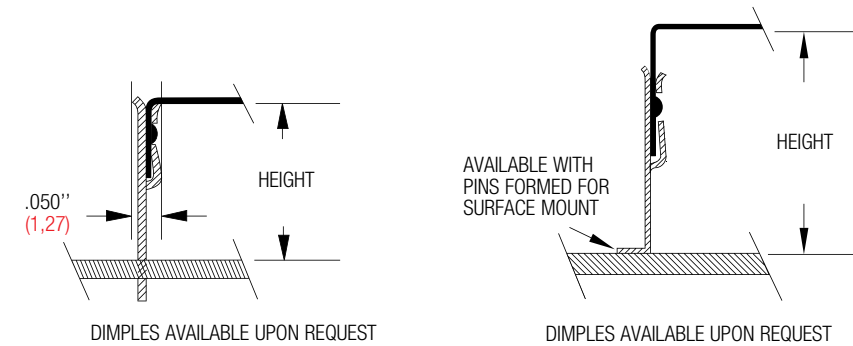

FIGURE 6 .25" Pin Spacing, No Standoff



CBS 50 Series Configuration



AVAILABLE HEIGHTS:
 50 SERIES - .50" TO 2.0" (12,7 TO 50,5)
 Recommended hole size: .050" (1,27)

Ventilation Patterns

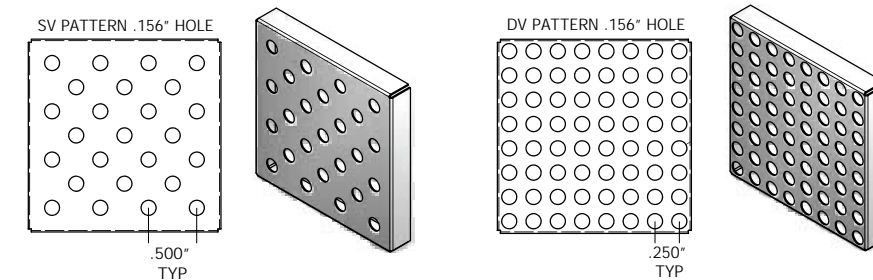

Single density and double density ventilation holes available upon request.
 SV/DV (Standard) = .156" SV2/DV2(Alternate) = .08"

Mounting Hole Patterns (50 series)

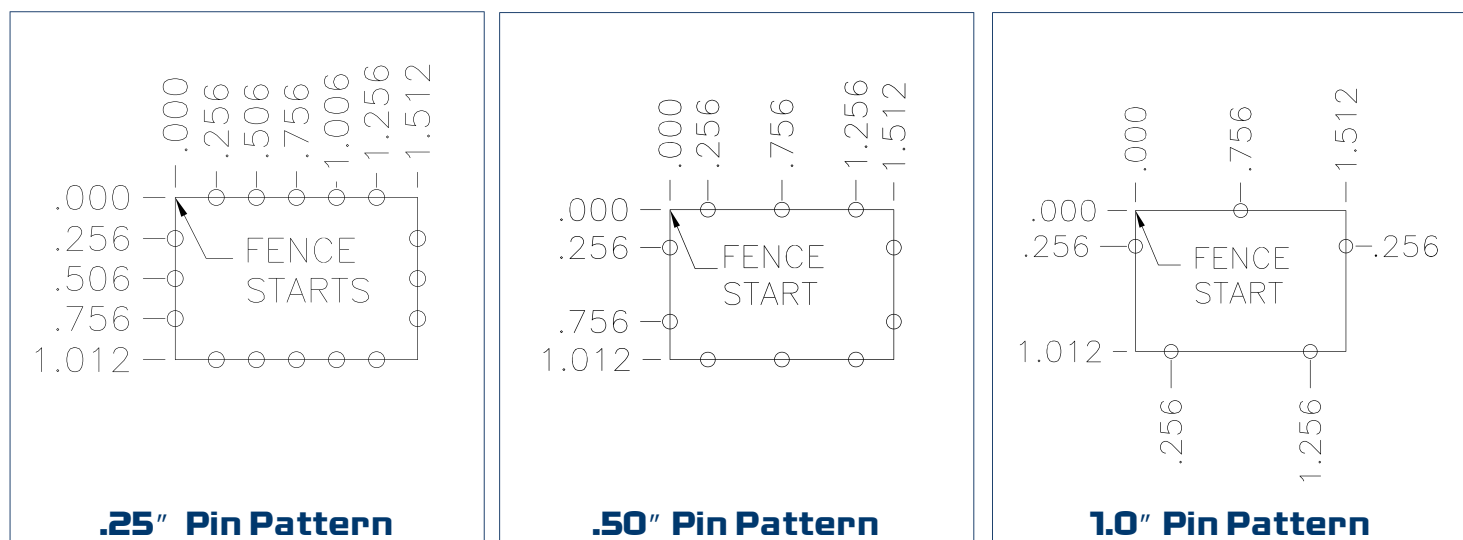

Pin pattern viewed from top of shield. Consult factory for pin patterns for your application

50 Series Specs

- Sizes:** .50" x .50" to 12" x 24" (.25" increments)
- Shapes:** Squares, Rectangles and Odd Shapes in .25" increments
- Heights:** .50" to 3.00"
- Mounting Pins:** .25", .50" or 1.00" spacing
- Surface Mount:** Available for all 50 series CBS
- Std Material:** .015" (.38) pre-tin plated steel
- Cover Retention:** 1.5 - 2.5 lb./linear inch
- Shielding Effectiveness:** up to 60 dB

Standard Options

- Formed fence and cover - unassembled (F)
- Assembled fence and cover (A)
- Flat fence and formed cover (U)
- Pre-tin plated Phos Bronze (P), Alloy 770 (N)
- Ventilation holes (SV 15% or DV 30%)
- Dimples for improved retention (D)

Ordering a CBS is Easy

1. Select your style number - "51-CBS"
2. Choose standard options listed above - "51-CBSFNSV"
3. Specify your width in .25" increments from .50" to 12.00" - "51-CBSFNSV-2.5"
4. Specify your length in .25" increments from .50" to 24.00" - "51-CBSFNSV-2.5x4.5"
5. Specify your height from board to inside cover from .50" to 2.00" - "51-CBSFNSV-2.5x4.5x.50"